

## Operating and installation instructions Cooker hood



To prevent the risk of accidents or damage to the appliance, it is **essential** to read these instructions before it is installed and used for the first time.

# Contents

---

<b>Warning and Safety instructions</b> .....	4
<b>Caring for the environment</b> .....	13
<b>Guide to the cooker hood</b> .....	14
<b>Modes of operation</b> .....	16
<b>Operation</b> .....	17
Switching on the fan.....	17
Selecting the power level .....	17
Run-on time.....	17
Switching the fan off .....	17
Switching the hob lighting on/off .....	17
Power management .....	18
Switching Power management on/off .....	18
Safety switch-off .....	18
<b>Energy saving tips</b> .....	19
<b>Cleaning and care</b> .....	20
Housing .....	20
Grease filter(s) .....	21
Replacing the grease filter.....	22
Charcoal filters .....	23
Disposing of charcoal filters .....	24
Reactivatable charcoal filters .....	24
<b>Service</b> .....	25
Contact in the event of a fault .....	25
Position of the data plate .....	25
Warranty .....	25
<b>Installation</b> .....	26
Before installation.....	26
Installation recommendations .....	26
Installation materials.....	26
Installation materials for recirculation mode.....	27
Appliance dimensions .....	28
Safety distance between hob and cooker hood (S) .....	31
Installing the depth stop (optional) .....	32
Connection for air extraction.....	34
Non-return flap .....	35
Condensation .....	35
Silencer.....	36

# Contents

---

Electrical connection .....	37
<b>Technical data</b> .....	38
Optional accessories for recirculation mode.....	38

## Warning and Safety instructions

---

This cooker hood complies with all relevant local and national safety requirements. Inappropriate use can, however, lead to personal injury and material damage.

Read the operating and installation instructions carefully before using the cooker hood. They contain important information on its safety, installation, use and maintenance. This prevents both personal injury and damage to the cooker hood.

In accordance with standard IEC 60335-1, Miele expressly and strongly advises that you read and follow the instructions in the chapter on installing the appliance as well as the safety instructions and warnings.

Miele cannot be held liable for injury or damage caused by non-compliance with these instructions.

Keep these instructions in a safe place and pass them on to any future owner.

### Correct application

▶ This cooker hood is intended for use in domestic households and similar working and residential environments.

▶ The cooker hood is not intended for outdoor use.

▶ It must only be used as a domestic appliance to extract vapours and remove odours from cooking.

Any other usage is not supported by the manufacturer and could be dangerous.

▶ Where a recirculation cooker hood is fitted above a gas hob, please ensure that there is an adequate supply of fresh air into the room in which it is installed. Please seek the advice of a qualified gas fitter (e.g. GasSafe in the UK) for more information if necessary.

## Warning and Safety instructions

---

▶ The cooker hood can only be used by people with reduced physical, sensory or mental capabilities, or lack of experience and knowledge, if they are supervised whilst using it, or have been shown how to use it in a safe way and recognise and understand the consequences of incorrect operation.

### **Safety with children**

- ▶ Children under 8 years of age must be kept away from the cooker hood unless they are constantly supervised.
- ▶ Children aged 8 and older may only use the cooker hood without supervision if they have been shown how to use it and are able to do so in a safe manner. Children must be able to understand and recognise the possible dangers caused by incorrect operation.
- ▶ Children must not be allowed to clean or maintain the cooker hood unsupervised.
- ▶ Please supervise children in the vicinity of the cooker hood and do not let them play with it.
- ▶ The hob lighting is very intensive.  
Ensure, in particular, that babies/small children do not look at the light.
- ▶ Danger of suffocation. Packaging, e.g. plastic wrappings, must be kept out of the reach of babies and children. Whilst playing, children could become entangled in packaging or pull it over their head and suffocate.

# Warning and Safety instructions

---

## Technical safety

- ▶ Unauthorised installation, maintenance and repairs can cause considerable danger for the user. Installation, maintenance and repairs must only be carried out by a Miele authorised technician.
- ▶ A damaged appliance can be dangerous. Check it for visible signs of damage. Do not use a damaged appliance.
- ▶ The electrical safety of this appliance can only be guaranteed when correctly earthed. It is essential that this standard safety requirement is met. If in any doubt please have the electrical installation tested by a qualified electrician.
- ▶ Temporary or permanent operation on an autonomous power supply system or a power supply system that is not synchronised with the mains power supply (e.g. island networks, back-up systems) is possible. A prerequisite for operation is that the power supply system complies with the specifications of EN 50160 or an equivalent standard.

The function and operation of the protective measures provided in the domestic electrical installation and in this Miele product must also be maintained in isolated operation or in operation that is not synchronised with the mains power supply, or these measures must be replaced by equivalent measures in the installation. As described, for example, in the current version of BS OHSAS 18001–2 ISO 45001.
- ▶ The connection data (voltage and frequency) on the data plate of the cooker hood must match the mains electricity supply in order to avoid the risk of damage to the cooker hood  
Compare this before connecting the appliance to the mains. Consult a qualified electrician if in any doubt.
- ▶ Do not connect the appliance to the mains electricity supply by a multi-socket unit or an extension lead. These are a fire hazard and do not guarantee the required safety of the appliance.

## Warning and Safety instructions

---

- ▶ EXT/EXTA model cooker hoods are connected to their external motor using a special connection cable and plug connectors. These appliances may only be combined with a Miele external motor.
- ▶ For safety reasons, this appliance may only be used after it has been built in.
- ▶ The cooker hood must not be used in a non-stationary location (e.g. on a ship).
- ▶ Touching electrical components and tampering with electrical and mechanical parts is highly dangerous to the user and can cause operational faults.  
Only open the housing as described in the instructions given in the installation sheet and in the Cleaning and care section of this booklet. Under no circumstances should any other parts of the housing be opened.
- ▶ The manufacturer's warranty will be invalidated if the appliance is not repaired by a Miele authorised technician.
- ▶ If the electrical connection cable is faulty it must only be replaced by a Miele authorised technician to protect the user from danger.
- ▶ The lamps are a built-in component of the lighting. Replacement lamps may only be fitted by a Miele authorised technician or by the Miele Customer Service Department.
- ▶ During installation, maintenance and repair work, the appliance must be disconnected from the mains electricity supply.

# Warning and Safety instructions

Using at the same time as another heating appliance that depends on the air from the room

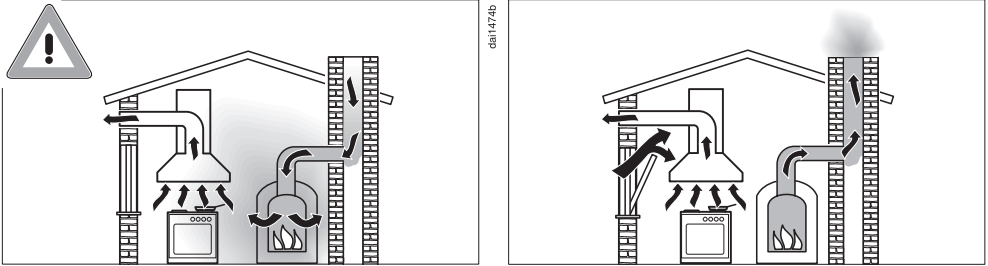

## Danger of toxic fumes!

Great care should be taken when using the cooker hood in the same room or the same area of the house at the same time as another heating appliance that depends on the air from the room. Such heating appliances draw in air from the room and duct exhaust gases out through a chimney or extraction ducting. They include gas, oil, wood and coal-fired boilers and heaters, continuous flow or other water heaters, gas hobs and ovens.

The cooker hood draws in air from the kitchen and from neighbouring rooms. This applies to the following modes of operation:

- extraction mode
- extraction mode with an external motor
- recirculation mode with a recirculation box installed outside the room

If there is insufficient air, negative pressure will occur. The heating appliance may be starved of oxygen. This impairs combustion. Harmful gases could be drawn from the chimney or extraction ducting back into the room.

**Risk of death!**

## Warning and Safety instructions

---

In order to ensure safe operation and to prevent gases given off by the heating appliance from being drawn back into the room when the cooker hood and the heater are both operated simultaneously, an underpressure in the room of 0.04 mbar (4 Pa) is the maximum permissible.

Sufficient ventilation can be maintained by air inlets which cannot be blocked, e.g. in windows, doors and outside wall vents. The cross-section of the inlet openings must enable sufficient ventilation. A ventilation brick alone is not generally sufficient to ensure safe ventilation.

The overall ventilation condition of the dwelling must be taken into account. If in any doubt, seek the advice of a competent building regulations inspector or qualified gas fitter (GasSafe in the UK).

If the cooker hood is being operated in recirculation mode, whereby the air is redirected into the room in which it is installed, the above restrictions do not apply.

# Warning and Safety instructions

---

## Correct use

▶ Open flames are a fire hazard.

The use of an open flame under the cooker hood is not permitted. To avoid the danger of fire, do not flambé or grill over an open flame.

When switched on, the cooker hood could draw flames into the filter. Fat deposits could ignite, presenting a fire hazard.

▶ The cooker hood can become damaged when exposed to excessive heat.

- When using the cooker hood over a gas hob, ensure that any burners in use are always covered by a pan. Switch the cooking zone off when a pan is removed, even for a short time.
- Select a pan which is suitable for the size of the burner.
- Regulate the flame so that it does not burn up the sides of the pan.
- Avoid overheating the pan (e.g. when cooking with a wok).

▶ Always switch the cooker hood on when a cooking zone is in use, otherwise condensation may collect in the hood, which could cause corrosion.

▶ Overheated oil and fat can ignite, causing fire damage to the cooker hood.

When cooking with oil or fat, chip pans and deep fat fryers, etc, do not leave the pans unattended. Similarly, never leave an open grill unattended when grilling.

## Warning and Safety instructions

---

▶ Do not use the cooker hood without the filters in place. This way you will avoid the risk of grease and dirt getting into the appliance and hindering its smooth operation.

▶ The cooker hood can get very hot during cooking due to heat rising from the hob.

Do not touch the housing or the grease filters until the cooker hood has cooled down.

### Proper installation

▶ To determine whether a cooker hood may be operated above your cooking appliance, please refer to the information provided by the appliance's manufacturer.

▶ Safety regulations prohibit the fitting of a cooker hood over solid fuel stoves.

▶ An insufficient safety distance between the hob and the cooker hood can result in damage to the cooker hood.

The minimum safety distances between the top of the hob and the bottom of the cooker hood given in the "Installation" section of this manual must be observed, unless the hob manufacturer states that a greater safety distance is required.

If more than one cooking appliance is fitted beneath the cooker hood, and they have different minimum safety distances to the cooker hood, select the greater distance.

▶ The information provided in "Installation" must be observed when fixing the ventilation hood.

▶ Components can have sharp edges which may cause injury. Wear gloves to protect your hands from being cut.

▶ Exhaust ducting must be of non-inflammable material. Suitable material is available from Miele specialist dealers or the Miele Spares Dept.

## Warning and Safety instructions

---

- ▶ The appliance must not be connected to a chimney or flue which is in use. Neither should it be connected to ducting which ventilates rooms with fireplaces.
- ▶ If exhaust air is to be extracted into a chimney or ventilation duct no longer used for other purposes, seek professional advice.

### Cleaning and care

- ▶ There is a risk of fire if the cooker hood is not cleaned as described in these operating instructions.
- ▶ Do not use a steam cleaning appliance to clean this appliance. The steam could reach electrical components and cause a short circuit.

### Accessories and spare parts

- ▶ Only use genuine original Miele accessories and spare parts with this appliance. Using accessories or spare parts from other manufacturers will invalidate the warranty and Miele cannot accept liability.
- ▶ Miele can only guarantee the safety of the appliance when genuine original Miele replacement parts are used. Faulty components must only be replaced by Miele spare parts.
- ▶ Miele will guarantee to supply functional spare parts for a minimum of 10 years and up to 15 years following the discontinuation of your vapour extraction unit.

### Disposing of the packaging material

The packaging material is used for handling and protects the appliance from transport damage. The packaging material used is selected from materials which are environmentally friendly for disposal and can generally be recycled.

Recycling the packaging material reduces the use of raw materials. Use material-specific collection points for valuable materials and take advantage of return options. Your Miele dealer will take the packaging material away.

### Disposing of your old appliance

Electrical and electronic appliances contain many valuable materials. They also contain certain materials, compounds and components which were essential for their correct functioning and safety. These could be hazardous to human health and to the environment if disposed of with household waste or if handled incorrectly. Please do not, therefore, dispose of your old appliance with household waste.



Instead, please make use of officially designated collection and disposal points to dispose of and recycle electrical and electronic appliances in your local community, with your dealer or with Miele, free of charge. By law, you are solely responsible for deleting any personal data from the old appliance prior to disposal. You are legally obliged to remove any old batteries which are not securely enclosed by the appliance and to remove any lamps without destroying them, where this is possible. These must be taken to a suitable collection point where they can be handed in free of charge. Please ensure that your old appliance poses no risk to children while being stored for disposal.

# Guide to the cooker hood

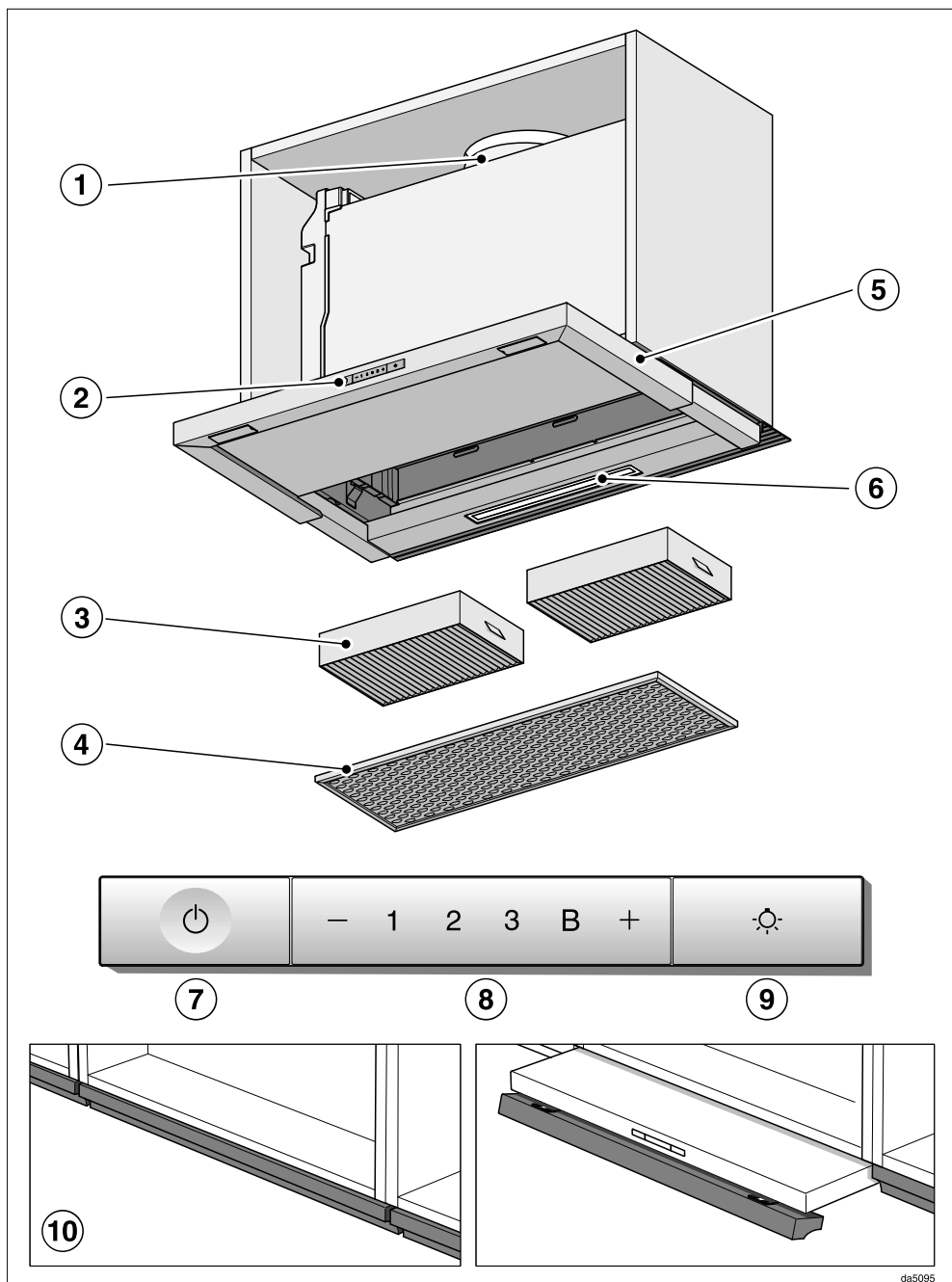

da5095

- ① Exhaust duct
- ② Control elements
- ③ Charcoal filter
  - Single-use or reactivatable charcoal filters
  - Optional accessories for recirculation mode
- ④ Grease filter
- ⑤ Pull-out deflector plate
- ⑥ Hob lighting
- ⑦ Control for switching the fan on and off
- ⑧ Controls for setting the fan power level
- ⑨ Control for switching the lighting on and off
- ⑩ Hinged front panel
  - The front of the deflector plate can be fitted with the front panel to match existing kitchen furniture units. Installation kit DML 2000 is required here (optional accessory).

# Modes of operation

Depending on the model of the cooker hood, the following options are available:

## Extraction mode



da10181a

The air is drawn in and cleaned by the grease filter and directed outside.

## Recirculation mode

Recirculation mode cooker hoods require a conversion kit and charcoal filters (see “Technical Data”)



da10181b

The air is drawn in and cleaned first by the grease filter and then by the charcoal filters. The cleaned air is then recirculated back into the kitchen.

## Operation with an external motor

(EXT/EXTA model cooker hoods)

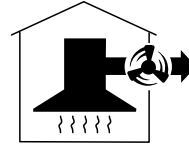

da10181c

Cooker hoods designed for use with an external motor have to be connected to a Miele external motor located in a position of your choice outside the room. The external motor is connected to the cooker hood by means of a control cable and is operated by the control elements on the cooker hood.

## Switching on the fan

Switch the fan on as soon as you start cooking. This is to ensure that vapours are captured right from the start.

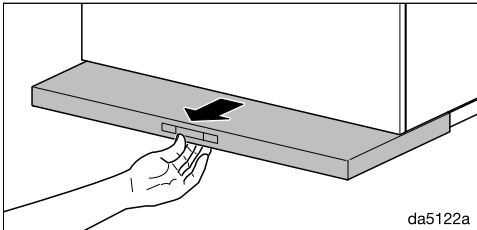

- Pull out the deflector plate. To ensure optimum extraction and a low noise level, pull the deflector plate all the way out.

The fan will come on at power level **2**.

## Selecting the power level

For light to heavy cooking vapours and odours, select from power levels **1** to **3**.

For short periods of cooking food with intensive vapours and a strong aroma, e.g. when searing meat, select Booster setting **B**.

- Select the power level you want by pressing the **-** or **+** control.

## Reducing power down from the Booster setting

If power management is activated (default setting), the fan automatically switches back to level **3** after 5 minutes.

## Run-on time

- It is advisable to run the fan for a few minutes after cooking has finished.

This helps to remove any lingering vapours and odours from the air.

It also reduces the risk of residues accumulating in the cooker hood and any resultant odours.

## Switching the fan off

- Turn off the fan by pushing the deflector plate back in. The next time the deflector plate is pulled out, the fan will switch on at setting **2** again.
- Use the On/Off control  to switch the fan off.

## Switching the hob lighting on/off

The hob lighting can be switched on and off independently of the fan.

- You can switch the hob lighting on and off by pulling the deflector plate out and pushing it in or by pressing the lighting control .

The  symbol will light up when the hob lighting is switched on.

# Operation

---

## Power management



The cooker hood is fitted with a power management system. Power management helps to save energy. It ensures that the fan power level is reduced automatically and that the lighting is switched off.

- If the Booster setting has been selected, the fan will automatically switch to level 3 after 5 minutes.
- From fan power levels 3, 2 or 1, the power will be reduced by one level after 2 hours and then in 30-minute stages until the fan finally switches off.
- The hob lighting will switch off automatically after 12 hours.

## Switching Power management on/off

You can deactivate Power management.

This can result in increased electricity consumption.

- To set this option, both the fan and the hob lighting must be switched off.
- Press the “—” and “+” controls at the same time for approx. 10 seconds, until the **1** lights up.
- Then press in turn,
  - the lighting control ,
  - the “—” button and then
  - the lighting control  again.

If Power management is switched on, the **1** and **B** indicators will light up constantly.

If it is switched off, **1** and **B** will flash.

- Press “—” to switch Power management off.

The **1** and **B** indicators will flash.

- To switch it on, press “+”.

The **1** and **B** indicators will light up constantly.



- Confirm your choice with the On/Off control .

All the indicator lamps will go out.

If you do not confirm within 4 minutes, the cooker hood will revert to the old setting.

## Safety switch-off

If Power management has been deactivated, the cooker hood will switch itself off automatically after 12 hours if it has been left on (fan and hob lighting).

- To switch it on again press the On/Off  control or the lighting control .

This cooker hood operates very efficiently and economically. The following will help you to save even more energy when using it:

- Ensure that there is sufficient ventilation in the kitchen when cooking. In extraction mode, if there is insufficient air flow the cooker hood cannot operate efficiently and this causes increased operating noise levels.
- Always cook with the lowest possible setting. This produces fewer cooking vapours, so you can use a lower cooker hood power level and therefore benefit from reduced energy consumption.
- Check the power level selected on the cooker hood. A lower power level is generally sufficient for the majority of cooking. Only use the Booster setting when necessary.
- When a large volume of cooking vapours is being produced, switch to a high power level in good time. This is more efficient than operating the cooker hood for longer to try to capture cooking vapours which have already been distributed throughout the kitchen.
- Make sure that you switch the cooker hood off after use.
- Clean or change the filters at regular intervals. Heavily soiled filters reduce performance, increase the risk of fire and are unhygienic.

# Cleaning and care

 Before proceeding with any maintenance or cleaning task, the cooker hood must be disconnected from the power supply (see “Warning and Safety instructions”).

## Housing

### General information

Unsuitable cleaning agents can damage the surfaces and control elements.

Do not use any cleaning agents containing soda, acid, chloride or solvent.

Do not use any abrasive cleaning agents, e.g. powder cleaners or cream cleaners and abrasive sponges, as well as pot scourers or sponges which have been used previously with abrasive cleaning agents.

 Moisture in the cooker hood can cause damage.  
Make sure that water does not get into the cooker hood.

- All external surfaces and control elements can be cleaned using hot water with a small amount of washing-up liquid applied with a well wrung-out soft sponge or cloth.
- After cleaning, wipe the surfaces dry using a soft cloth.

### Important information for appliances with stainless steel surfaces

This information does not apply to the control buttons.

Stainless steel surfaces can be cleaned with a non-abrasive cleaning agent designed specifically for use on stainless steel.

To prevent the surfaces from quickly becoming dirty again, we recommend treating them with a stainless steel care product (available from Miele).

### Important information for the control elements

If soiling is not removed promptly, it could cause the control elements to alter or discolour.

Remove any soiling immediately.

The surface of the control elements can become damaged if they are cleaned using stainless steel cleaning agents.

Do not use stainless steel cleaning agents on the control elements.

## Grease filter(s)

### Fire hazard

An oversaturated grease filter is a fire hazard.

Clean the grease filter at regular intervals.

The re-usable metal grease filter in the appliance remove solid particles from the kitchen vapours (grease, dust, etc.), preventing soiling of the cooker hood.

The grease filter must be cleaned at regular intervals.

A heavily soiled grease filter hinders air extraction and will lead to increased levels of soiling in the cooker hood and in the kitchen.

## Cleaning interval

Accumulated grease solidifies over a longer period of time and makes cleaning more difficult. The grease filter(s) should therefore be cleaned at least every 3 to 4 weeks.

## Removing a grease filter

 When handling a grease filter, be careful not to drop it.

This can result in damage to the filter and the hob below.

Make sure you hold the filter securely at all times when handling it.

- Pull out the deflector plate.

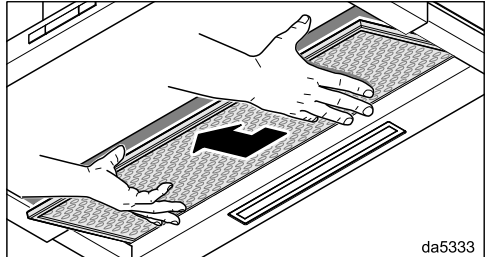
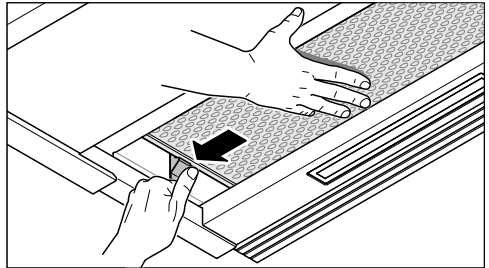

- Support the grease filter with your right hand. Press down on the lock on the left-hand side.
- Pull the grease filter down to remove it.

## Cleaning the grease filter by hand

- Clean the filter with a soft nylon brush in a mild solution of hot water and a small amount of washing-up liquid. Do not use “neat” washing up liquid.

# Cleaning and care

## Unsuitable cleaning agents

Unsuitable cleaning agents can cause damage to the surface of the filters if used regularly.

Do not use:

- cleaning agents containing descaling agents
- powder cleaners, cream cleaners
- aggressive multi-purpose cleaning agents or spray cleaners for grease
- oven sprays

## Cleaning the grease filter in a dishwasher

- Place the grease filter upright or slightly inclined in the lower basket. Ensure the spray arm is not obstructed.
- Use a commercially available household dishwasher detergent.
- Select a dishwasher programme with a wash temperature between 50 °C and 65 °C.

Depending on the detergent used, cleaning the grease filter in a dishwasher can cause permanent discolouration to the internal surfaces of the filter. However, this will not affect the functioning of the grease filter in any way.

## After cleaning

- After cleaning, leave the filter to dry on an absorbent surface before replacing it.
- When removing the filter for cleaning, also clean off any residues of oil or fat from the now accessible casing to prevent the risk of these catching fire.

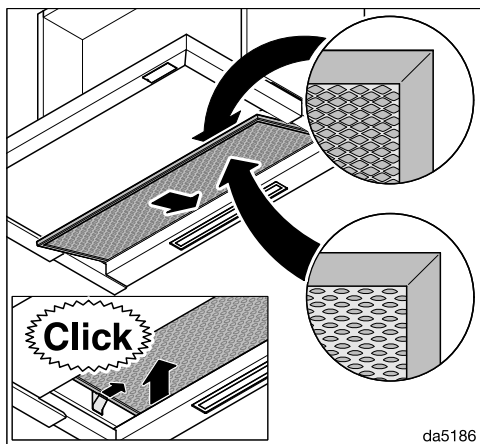

- Replace the grease filter.

## Replacing the grease filter

Regular usage and cleaning can cause the filter surfaces to become worn.

If you identify any damage, replace the grease filter.

Grease filters are available to order via the Miele Customer Service Department (see end of these operating instructions for contact details) or from your Miele dealer.

## Charcoal filters

With recirculation mode, two charcoal filters must be inserted in addition to the grease filter. These are designed to absorb cooking odours.

The charcoal filters are fitted in the deflector plate above the grease filter.

Charcoal filters are available to order via the Miele Webshop, the Miele Spare Parts Department (see end of this booklet for contact details) or from your Miele dealer.

The charcoal filters are listed under "Technical data" at the back of this booklet.

## Fitting/replacing charcoal filters

The matching frames must be installed in order to use the charcoal filters. Follow the directions on the installation sheet.

- Remove the grease filter from the cooker hood.
- Remove the charcoal filter packaging.

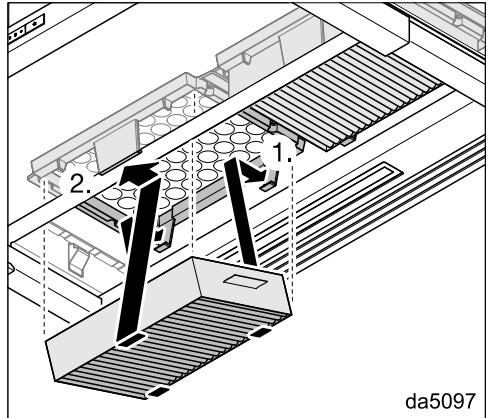

- Push the charcoal filters into the frames until they engage firmly.
- Replace the grease filter.
- To remove the charcoal filters, press the holder clip forwards slightly and pull the filters down to remove them.

# Cleaning and care

---

## **When to change the charcoal filters**

Replace the charcoal filters when they no longer absorb kitchen odours effectively, and at least every 6 months.

## **Disposing of charcoal filters**

- Used charcoal filters can be disposed of with normal household waste.

## **Reactivatable charcoal filters**

Reactivatable charcoal filters are available for this cooker hood. They can be used several times after being reactivated in the oven.

Please follow the operating instructions supplied with the filters.

## Contact in the event of a fault

In the event of any faults which you cannot remedy yourself, please contact your Miele dealer or the Miele Customer Service Department.

You can book a Miele Customer Service Department call-out online at [www.miele.com/service](http://www.miele.com/service).

Contact information for the Miele Customer Service Department can be found at the end of this document.

Please quote the model identifier and serial number of your appliance (Fabr./SN/Nr.) when contacting the Miele Customer Service Department. This information can be found on the data plate.

Please note that telephone calls may be monitored and recorded for training purposes and that a call-out charge will be applied to service visits where the problem could have been resolved as described in this booklet.

## Position of the data plate

The data plate is visible once you have removed the grease filter and, in the case of recirculation mode, the charcoal filters.

## Warranty

For information on the appliance warranty specific to your country please contact Miele. See back cover for address.

In the UK, your appliance warranty is valid for 2 years from the date of purchase. However, you must activate your cover by calling 0330 160 6640 or registering online at [www.miele.co.uk](http://www.miele.co.uk).

# Installation

## Before installation

 Before installation, it is important to read the information given on the following pages as well as the “Warning and Safety instructions” at the beginning of this booklet.

## Installation recommendations

- To achieve optimum vapour extraction, the cooker hood must be positioned centrally over the hob, not to the side.
- The hob should be no wider than the cooker hood, and if possible, it should be narrower.
- The installation area must be easily accessible. The cooker hood should be easily accessible and easy to dismantle in the event that service is required. This should be taken into consideration when planning the position of cupboards, shelves, ceilings or features in the vicinity of the cooker hood.

## Installation materials

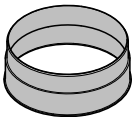

**1 vent connection**  
for exhaust ducting  $\varnothing$  150 mm.

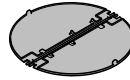

**1 non-return flap**  
for fitting into the exhaust socket on the motor unit (not needed for recirculation mode).

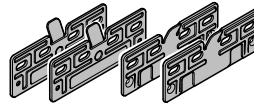

**4 mounting plates**  
for installation in a 600 mm wide cabinet

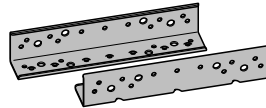

**2 brackets**  
for installation in a 900 mm wide cabinet (only for 900 mm wide appliances)

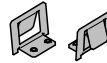

**2 spring clips**  
for installation in a 900 mm wide cabinet (only for 900 mm wide appliances)

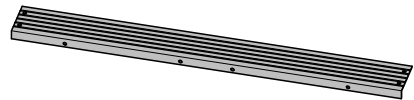

**1 spacer strip**  
for concealing the gap between the rear of the appliance and the wall

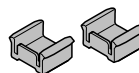

**2 depth stops**  
to limit how far the deflector plate can be pushed in

11780500

11574700

08268021

06363320

11597850

11940470



4 screws, M4 x 8 mm



4 (8)\* screws, 4 x 15 mm

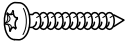

4 screws, 4 x 30 mm



8 (12)\* screws, 4 x 15 mm



4 screws, M4 x 12 mm\*



4 screws, M4 x 8.5 mm\*



2 screws, 3.9 x 7.5 mm with cover caps

\* For 896 mm wide appliances

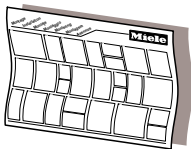

## Installation plan

See the installation plan for details on the individual steps involved in the installation of this appliance.

06095672

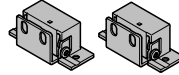

11839870

## DML 2000 installation kit

for installing a hinged front panel to match kitchen furniture units (not supplied; available as an optional accessory)

01056271

09879120

## Installation materials for recirculation mode

You need the following optional accessories for recirculation mode:

04832511

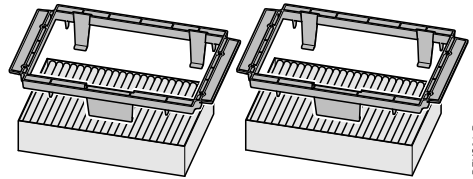

DFKS31-P

07270730

## DKFS 31-x installation kit

contains 2 holders and 2 charcoal filters (DKFS 31-P with single-use charcoal filters or DKFS 31-R with reactivatable charcoal filters)

06462181

18850mlap

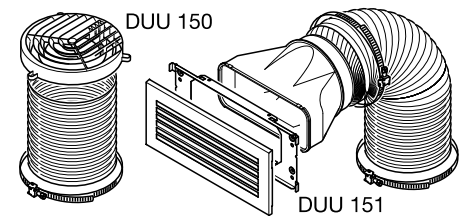

DUU 150 151

dina3mie

## DUU 15x installation kit

contains a directional unit socket, hose and hose clips (DUU 150 for the top of the cabinet or DUU 151 for the sides or front of the cabinet)



Dia. 2: DA 2920 in a 900 mm wide cabinet.

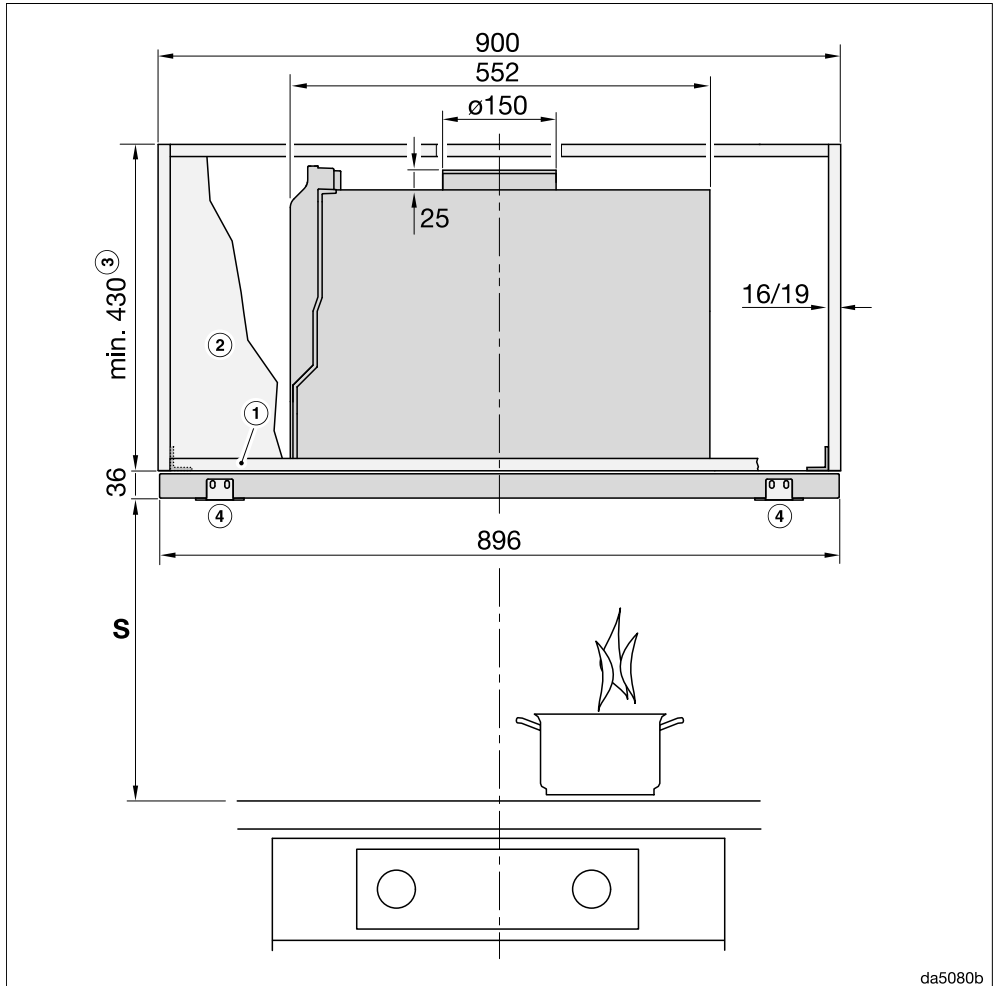

da5080b

The drawing is not to scale

See diagram 1 for side view

# Installation

Dia. 3: DAS 2920 in a 600 mm wide cabinet or in a 900 mm wide cabinet with side compartments.

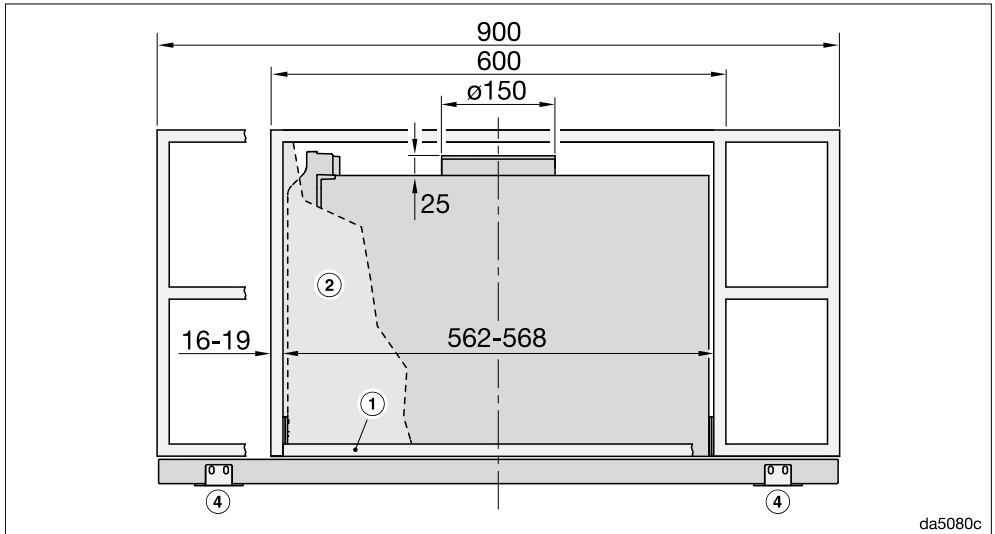

The drawing is not to scale

See diagram 1 for side view

Footnotes for diagrams 1 to 3:

- ① The front section of the cabinet must be fitted with a base panel to secure the cooker hood.
- ② If a partition wall is to be provided in the cabinet, it must be removable.
- ③ Extraction or recirculation with conversion kit DUU 150
- ④ DML 2000 bracket (optional accessory) for fitting a front panel
- ⑤ Can be adjusted via depth stop

\* In this installation situation, the deflector plate is flush with the front edge of the housing unit carcass. If you wish to position the cooker hood further forward or further back, you must adapt the dimensions accordingly (e.g. if you are using a front panel).

The height of the cabinet and the cut-out dimensions must take into account any accessories fitted (e.g. silencer, recirculation hood conversion kit).

## Safety distance between hob and cooker hood (S)

When planning the installation height of your cooker hood, the minimum safety distance between the top of a cooker or hob and the bottom of the cooker hood is as follows, unless a greater distance is specified by the manufacturer of your cooking appliance.

See “Warning and Safety” instructions for further information.

Cooking appliance	Minimum distance S
Electric hob	450 mm
Electric grill, deep fat fryer (electric)	650 mm
Multi-burner gas hob, total output $\leq 12.6$ kW, no burner $> 4.5$ kW	650 mm
Multi-burner gas hob, total output $> 12.6$ kW and $\leq 21.6$ kW, no burner $> 4.8$ kW.	760 mm
Multi-burner gas hob, total output $> 21.6$ kW, or multi-burner gas hob where one burner $> 4.8$ kW.	Not possible
Single burner gas hob, output $\leq 6$ kW.	650 mm
Single burner gas hob, output $> 6$ kW and $\leq 8.1$ kW.	760 mm
Single burner gas hob, output $> 8.1$ kW	Not possible

If you are fitting a front panel made of wood or plastic to the cooker hood, observe the safety distances given by the hob manufacturer regarding the use of easily flammable materials.

# Installation

## Installing the depth stop (optional)

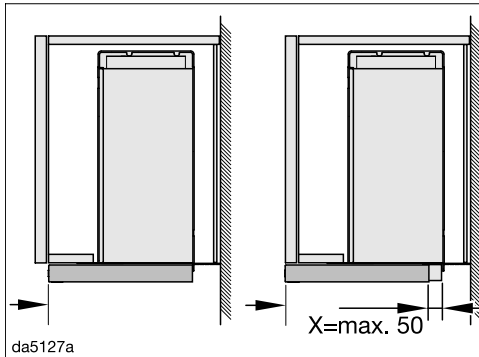

You can limit how far the deflector plate can be pushed in.

For example, if the deflector plate should sit flush with the front edge of the cabinet door when pushed in, rather than with the front edge of the cabinet housing, you can position the depth stop accordingly.

You can move the stop forward by up to 50 mm.

You must insert the depth stops into the recesses of the deflector plate prior to installing the cooker hood. You can fix the depth stops in the required position on completion of installation.

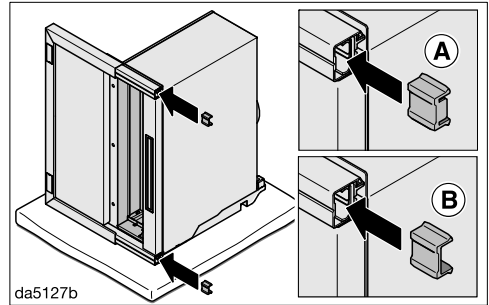

■ Insert the depth stops into the recesses of the deflector plate from behind. The alignment is determined by how far forward you wish to move the stop.

- Ⓐ X = 2 to 18 mm: depth stop lip facing backward
- Ⓑ X = 19 to 50 mm: depth stop lip facing forward

■ Install the cooker hood.

■ Pull out the deflector plate.

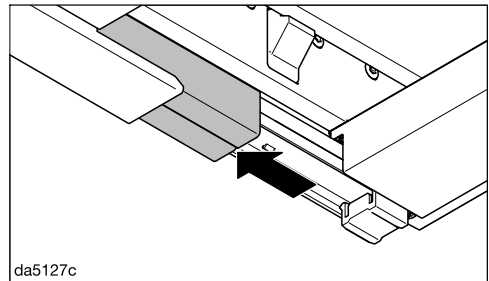

■ Slide the recess covers forward.

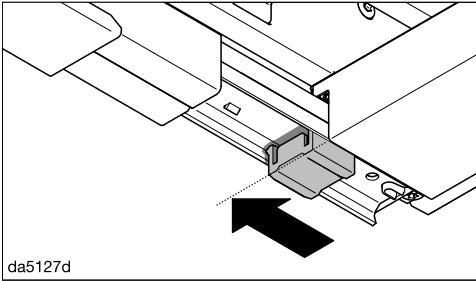

da5127d

- Slide the depth stops forward to the position shown.

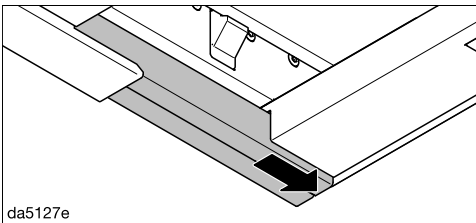

da5127e

- Slide the covers back again.

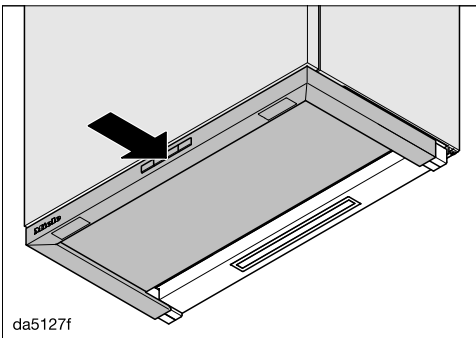

da5127f

- Carefully push in the deflector plate as far as the required position.

This will push the depth stops into the required position.

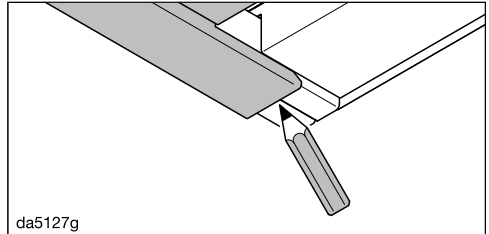

da5127g

- Use a pen to mark the back edge of the deflector plate on the cover.
- Pull out the deflector plate.

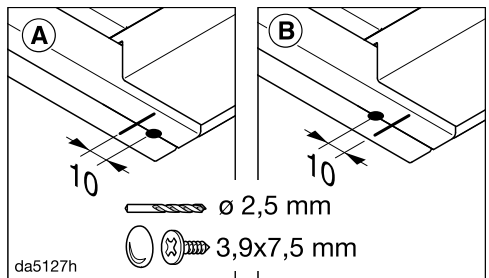

da5127h

- To fix the depth stops in place, screw the 3.9 x 7.5 mm screws through the covers. The position of the screws is determined by which way around the depth stops have been inserted.
  - (A) Depth stop lip facing backward: 10 mm in front of the pen mark
  - (B) Depth stop lip facing forward: 10 mm behind the pen mark

# Installation

## Connection for air extraction

**⚠** If the cooker hood is used at the same time as a heating appliance that relies on oxygen from the same room, there is a risk in certain circumstances of toxic fumes building up.

It is essential that the “Warning and Safety” instructions are observed.

The cooker hood should be installed according to local and national building regulations. Seek approval from the building inspector where necessary.

Only use smooth pipes or flexible exhaust ducting made from approved non-flammable materials for exhaust ducting.

Use rigid exhaust ducting for ... EXT/EXTA model cooker hoods. The external motor can cause an underpressure which can result in the exhaust ducting distorting.

To achieve the most efficient air throughput with the lowest noise levels, please note the following:

- The diameter of the exhaust ducting must not be smaller than the cross-section of the exhaust duct (see “Appliance dimensions”). This applies in particular when using flat ducting.
- The exhaust ducting should be as short and straight as possible.
- Only use wide radius bends.
- The exhaust ducting must not be kinked or compressed.

- All connections must be strong and airtight.
- If the exhaust ducting has flaps, these must be opened whenever the cooker hood is switched on.

Any constriction of the air throughput will reduce extraction performance and increase operating noise.

## Flue

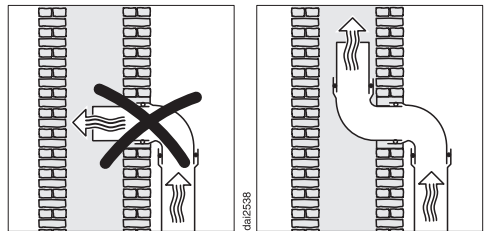

If the exhaust air is to be ducted into a flue, the ducting must be directed in the flow direction of the flue.

If the flue is used by several ventilation units, the cross-section of the flue must be large enough.

## Non-return flap

- Use a non-return flap in the exhaust system.

A non-return flap ensures that when the cooker hood is not in operation, the duct is closed to prevent unwanted exchange of room air and outside air.

If the exhaust is ducted through an outside wall, a Miele wall vent or roof vent (available as an optional accessory) is recommended. Both of these have a built-in non-return flap.

If the on-site ventilation system does not have a non-return flap, one is supplied with the cooker hood.

The non-return flap is fitted in the exhaust socket of the fan.

## Condensation

If the exhaust ducting is to run through cool rooms or ceiling space, for example, the significant variations in temperature between the different areas can cause condensation to form. Insulate the exhaust ducting to reduce temperature variations.

If the exhaust ducting is to be laid horizontally, it must be laid with a downwards sloping gradient of at least 1 cm per meter. This is to ensure that condensation cannot drain back into the cooker hood.

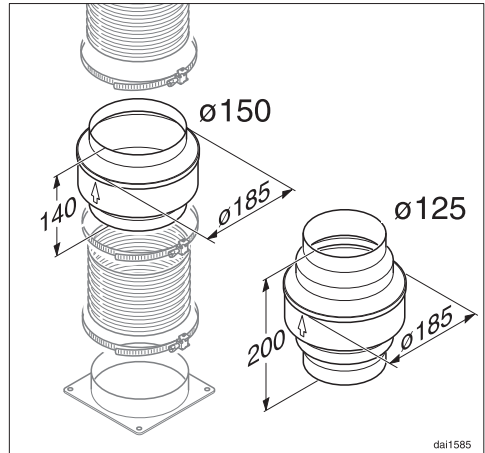

In addition to insulating the exhaust ducting, it is advisable to also install a condensate trap for collecting and evaporating any potential condensation.

Condensate traps for 125 mm or 150 mm diameter exhaust ducting are available as optional accessories.

When installing a condensate trap, ensure that it is positioned vertically and as closely as possible to the cooker hood above the exhaust connection. The arrow on the casing indicates the direction of airflow.

The condensate trap will be integrated in cooker hoods which are designed to be connected to an external motor (EXT/EXTA models).

Miele shall not accept warranty claims for any functional defects or damage caused by inadequate exhaust ducting.

# Installation

## Silencer

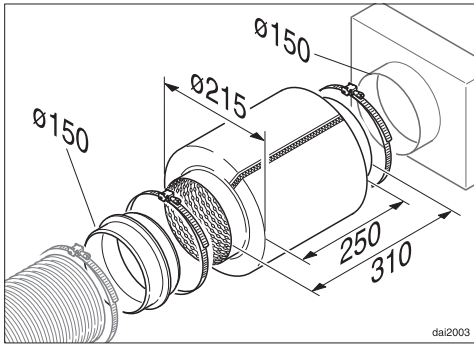

To reduce noise levels even further, a silencer (optional accessory) can be installed in the exhaust ducting.

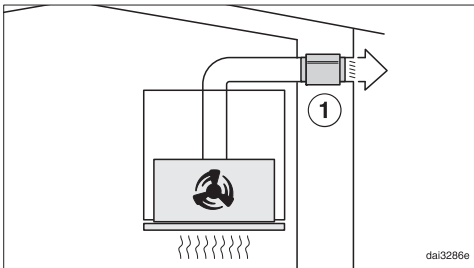

In extraction mode, the silencer not only reduces noise from the fan outside the house, but also sounds originating outside reaching the kitchen through the exhaust ducting (e.g. traffic noise). For this reason, the silencer must be positioned as close as possible to the ducting exit (1).

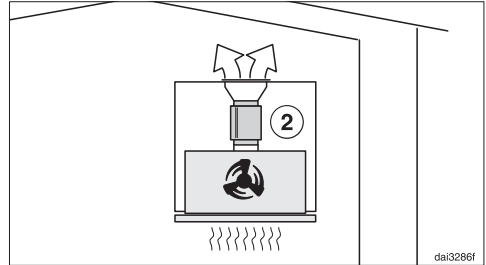

In recirculation mode, the silencer needs to be positioned between the exhaust vent and the exhaust grille (2). Check that there is sufficient space.

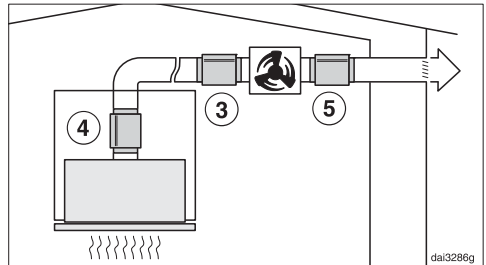

For operation with an external motor, noise from the motor outside the house and inside the kitchen can be minimised.

Positioning the silencer in front of the external motor (3) reduces noise inside the kitchen. If the exhaust ducting is long, the silencer needs to be positioned at the exhaust duct in the ducting above the cooker hood itself (4). For an external motor installed inside the house, noise from the motor outside the house can be reduced by positioning the silencer behind the external motor (5).

## Electrical connection

The cooker hood is supplied with a mains cable with moulded plug ready for connection to a suitable earthed socket.

If the socket is not easily accessible or a fixed connection is envisaged, ensure that a suitable means of disconnection is provided on the installation side for each pole.

 Risk of fire from overheating. Connecting the cooker hood to multi-socket adapters or extension cables can overload the cables. For safety reasons, do not use an extension cable or multi-socket adapter.

The electrical system must comply with local and national safety regulations (BS 7671 in the UK).

For safety reasons, we recommend using a type  residual current device (RCD) in the relevant electrical installation for connecting the cooker hood.

If the mains connection cable is damaged, it must only be replaced with a specific mains connection cable of the same type (available from the Miele Customer Service Department). For safety reasons, such replacement may only be carried out by a qualified specialist or the Miele Customer Service Department.

These operating instructions and the data plate indicate the nominal power consumption and the appropriate fuse rating. Compare this information with the data of the on-site electrical

connection.

If in any doubt, consult a qualified electrician.

Temporary or permanent operation on an autonomous power supply system or a power supply system that is not synchronised with the mains power supply (e.g. island networks, back-up systems) is possible. A prerequisite for operation is that the power supply system complies with the specifications of EN 50160 or an equivalent standard. The function and operation of the protective measures provided in the domestic electrical installation and in this Miele product must also be maintained in isolated operation or in operation that is not synchronised with the mains power supply, or these measures must be replaced by equivalent measures in the installation. As described, for example, in the current version of VDE-AR-E 2510-2.

## Technical data

Fan motor*	200 W
Hob lighting	3.2 W
Total rated load*	203.2 W
Mains voltage, frequency	AC 230 V, 50 Hz
Fuse rating	10 A
Length of mains connection cable	1.5 m
Weight	
DAS 2620	12 kg
DAS 2920	14 kg
DAS 2620 EXTA	9 kg
DAS 2920 EXTA	11 kg

\* For EXTA models, the rated load will depend on the type of external motor fitted.  
Length of connection cable to external motor: 1.9 m

### Optional accessories for recirculation mode

You need the following installation kits for recirculation mode:

- DUU 150 or DUU 151
- DKFS 31-P or DKFS 31-R (reactivatable). The installation kits contain 2 charcoal filters and the required original equipment installation frames.

Charcoal filters DKF 31-P or DKF 31-R (reactivatable) must be purchased as an optional accessory. The packs contain 2 charcoal filters.

## Data sheet for household cooker hoods

In acc. with delegated regulation (EU) No. 65/2014 and regulation (EU) No. 66/2014

<b>MIELE</b>	
<b>Model name/identifier</b>	DAS 2620
Annual Energy Consumption (AEC <sub>hood</sub> )	41,7 kWh/year
Energy efficiency class	A
Energy efficiency index (EEI <sub>hood</sub> )	50,2
Fluid Dynamic Efficiency (FDE <sub>hood</sub> )	30,6
Fluid Dynamic Efficiency class	
A (most efficient) to G (least efficient)	A
Lighting Efficiency (LE <sub>hood</sub> )	96,9 lx/W
Lighting Efficiency class	
A (most efficient) to G (least efficient)	A
Grease Filtering Efficiency	95,6%
Grease Filtering Efficiency class	
A (most efficient) to G (least efficient)	A
Airflow at best efficiency point	312,6 m <sup>3</sup> /h
Air flow (min. speed)	198 m <sup>3</sup> /h
Air flow (max. speed)	413 m <sup>3</sup> /h
Air flow (intensive or boost setting)	559 m <sup>3</sup> /h
Max. air flow (Q <sub>max</sub> )	559 m <sup>3</sup> /h
Air pressure at best efficiency point	422 Pa
Airborne acoustical A-weighted sound power emissions (min. speed)	47 dB
Airborne acoustical A-weighted sound power emissions (max. speed)	61 dB
Airborne acoustical A-weighted sound power emissions (intensive or boost setting)	68 dB
Electrical power input at best efficiency point	119,9 W
Power consumption in off mode (P <sub>o</sub> )	W
Power consumption in standby mode (P <sub>s</sub> )	0,25 W
Nominal power of lighting system	3,2 W
Average illumination of the lighting system on the cooking surface	310 lx
Time increase factor	0,9

# Technical data

## Data sheet for household cooker hoods

In acc. with delegated regulation (EU) No. 65/2014 and regulation (EU) No. 66/2014

<b>MIELE</b>	
<b>Model name/identifier</b>	DAS 2920
Annual Energy Consumption (AEC <sub>hood</sub> )	42,0 kWh/year
Energy efficiency class	A
Energy efficiency index (EEI <sub>hood</sub> )	50,4
Fluid Dynamic Efficiency (FDE <sub>hood</sub> )	30,6
Fluid Dynamic Efficiency class	
A (most efficient) to G (least efficient)	A
Lighting Efficiency (LE <sub>hood</sub> )	85,9 lx/W
Lighting Efficiency class	
A (most efficient) to G (least efficient)	A
Grease Filtering Efficiency	95,2%
Grease Filtering Efficiency class	
A (most efficient) to G (least efficient)	A
Airflow at best efficiency point	311,4 m <sup>3</sup> /h
Air flow (min. speed)	204 m <sup>3</sup> /h
Air flow (max. speed)	420 m <sup>3</sup> /h
Air flow (intensive or boost setting)	561 m <sup>3</sup> /h
Max. air flow (Q <sub>max</sub> )	561 m <sup>3</sup> /h
Air pressure at best efficiency point	427 Pa
Airborne acoustical A-weighted sound power emissions (min. speed)	47 dB
Airborne acoustical A-weighted sound power emissions (max. speed)	61 dB
Airborne acoustical A-weighted sound power emissions (intensive or boost setting)	69 dB
Electrical power input at best efficiency point	120,7 W
Power consumption in off mode (P <sub>o</sub> )	W
Power consumption in standby mode (P <sub>s</sub> )	0,25 W
Nominal power of lighting system	3,2 W
Average illumination of the lighting system on the cooking surface	275 lx
Time increase factor	0,9

## Data sheet for household cooker hoods

In acc. with delegated regulation (EU) No. 65/2014 and regulation (EU) No. 66/2014

<b>MIELE</b>	
<b>Model name/identifier</b>	DAS 2620 EXTA
Annual Energy Consumption (AEC <sub>hood</sub> )	109,5 kWh/year
Energy efficiency class	C
Energy efficiency index (EEI <sub>hood</sub> )	77,5
Fluid Dynamic Efficiency (FDE <sub>hood</sub> )	19,9
Fluid Dynamic Efficiency class	
A (most efficient) to G (least efficient)	C
Lighting Efficiency (LE <sub>hood</sub> )	96,9 lx/W
Lighting Efficiency class	
A (most efficient) to G (least efficient)	A
Grease Filtering Efficiency	95,6%
Grease Filtering Efficiency class	
A (most efficient) to G (least efficient)	A
Airflow at best efficiency point	431,9 m <sup>3</sup> /h
Air flow (min. speed)	325 m <sup>3</sup> /h
Air flow (max. speed)	590 m <sup>3</sup> /h
Air flow (intensive or boost setting)	729 m <sup>3</sup> /h
Max. air flow (Q <sub>max</sub> )	729 m <sup>3</sup> /h
Air pressure at best efficiency point	375 Pa
Airborne acoustical A-weighted sound power emissions (min. speed)	48 dB
Airborne acoustical A-weighted sound power emissions (max. speed)	63 dB
Airborne acoustical A-weighted sound power emissions (intensive or boost setting)	69 dB
Electrical power input at best efficiency point	225,9 W
Power consumption in off mode (P <sub>o</sub> )	W
Power consumption in standby mode (P <sub>s</sub> )	0,25 W
Nominal power of lighting system	3,2 W
Average illumination of the lighting system on the cooking surface	310 lx
Time increase factor	1,3

The above values were determined in combination with the Miele ABLG 202 external motor.

# Technical data

## Data sheet for household cooker hoods

In acc. with delegated regulation (EU) No. 65/2014 and regulation (EU) No. 66/2014

<b>MIELE</b>	
<b>Model name/identifier</b>	DAS 2920 EXTA
Annual Energy Consumption (AEC <sub>hood</sub> )	109,5 kWh/year
Energy efficiency class	C
Energy efficiency index (EEI <sub>hood</sub> )	77,5
Fluid Dynamic Efficiency (FDE <sub>hood</sub> )	19,9
Fluid Dynamic Efficiency class	
A (most efficient) to G (least efficient)	C
Lighting Efficiency (LE <sub>hood</sub> )	85,9 lx/W
Lighting Efficiency class	
A (most efficient) to G (least efficient)	A
Grease Filtering Efficiency	95,2%
Grease Filtering Efficiency class	
A (most efficient) to G (least efficient)	A
Airflow at best efficiency point	431,9 m <sup>3</sup> /h
Air flow (min. speed)	325 m <sup>3</sup> /h
Air flow (max. speed)	590 m <sup>3</sup> /h
Air flow (intensive or boost setting)	729 m <sup>3</sup> /h
Max. air flow (Q <sub>max</sub> )	729 m <sup>3</sup> /h
Air pressure at best efficiency point	375 Pa
Airborne acoustical A-weighted sound power emissions (min. speed)	48 dB
Airborne acoustical A-weighted sound power emissions (max. speed)	63 dB
Airborne acoustical A-weighted sound power emissions (intensive or boost setting)	69 dB
Electrical power input at best efficiency point	225,9 W
Power consumption in off mode (P <sub>o</sub> )	W
Power consumption in standby mode (P <sub>s</sub> )	0,25 W
Nominal power of lighting system	3,2 W
Average illumination of the lighting system on the cooking surface	275 lx
Time increase factor	1,3

The above values were determined in combination with the Miele ABLG 202 external motor.

## United Kingdom

Miele Co. Ltd., Fairacres, Marcham Road, Abingdon, Oxon, OX14 1TW

Tel: 0330 160 6600, Internet: [www.miele.co.uk/service](http://www.miele.co.uk/service), E-mail: [info@miele.co.uk](mailto:info@miele.co.uk)

### Australia

Miele Australia Pty. Ltd.

ACN 005 635 398

ABN 96 005 635 398

Level 4, 141 Camberwell Road

Hawthorn East, VIC 3123

Tel: 1300 464 353

Internet: [www.miele.com.au](http://www.miele.com.au)

### China Mainland

Miele Electrical Appliances Co., Ltd.

1-3 Floor, No. 82 Shi Men Yi Road  
Jing' an District

200040 Shanghai, PRC

Tel: +86 21 6157 3500

Fax: +86 21 6157 3511

E-mail: [info@miele.cn](mailto:info@miele.cn),

Internet: [www.miele.cn](http://www.miele.cn)

### Hong Kong, China

Miele (Hong Kong) Ltd.

41/F - 4101, Manhattan Place

23 Wang Tai Road

Kowloon Bay, Hong Kong

Tel: (852) 2610 1025

Fax: (852) 3579 1404

Email:

[customerservices@miele.com.hk](mailto:customerservices@miele.com.hk)

Website: [www.miele.hk](http://www.miele.hk)

### India

Miele India Pvt. Ltd.

1st Floor, Copia Corporate Suites,  
Commercial Plot 9,

Mathura Road, Jasola,

New Delhi - 110025

E-mail: [customercare@miele.in](mailto:customercare@miele.in)

Website: [www.miele.in](http://www.miele.in)

**Manufacturer:** Miele & Cie. KG, Carl-Miele-Straße 29, 33332 Gütersloh, Germany

### Ireland

Miele Ireland Ltd.

2024 Bianconi Avenue

Citywest Business Campus

Dublin 24

Tel: (01) 461 07 10

Fax: (01) 461 07 97

E-Mail: [info@miele.ie](mailto:info@miele.ie)

Internet: [www.miele.ie](http://www.miele.ie)

### Kuwait

Miele Kuwait

Al Wazzan United Trading Co.

P. O. Box : 3379

Hawally, 32034 Kuwait

Tel.: 00965-22001010

Fax: 00965-24838292

E-mail: [mail@alwazzanunited.com](mailto:mail@alwazzanunited.com)

Website: [www.alwazzanunited.com](http://www.alwazzanunited.com)

### Malaysia

Miele Sdn Bhd

Suite 12-2, Level 12

Menara Sapura Kencana

Petroleum

Solaris Dutamas No. 1

Jalan Dutamas 1

50480 Kuala Lumpur, Malaysia

Phone: +603-6209-0288

Fax: +603-6205-3768

### New Zealand

Miele New Zealand Limited

IRD 98 463 631

8 College Hill

Freemans Bay, Auckland 1011

New Zealand

Tel: 0800 464 353

Internet: [www.miele.co.nz](http://www.miele.co.nz)

### Singapore

Miele Pte. Ltd.

29 Media Circle

#11-04 ALICE@Mediapolis

Singapore 138565

Tel: +65 6735 1191

Fax: +65 6735 1161

E-Mail: [info@miele.com.sg](mailto:info@miele.com.sg)

Internet: [www.miele.sg](http://www.miele.sg)

### South Africa

Miele (Pty) Ltd.

63 Peter Place, Bryanston 2194

P.O. Box 69434, Bryanston 2021

Tel: (011) 875 9000

Fax: (011) 875 9035

E-mail: [info@miele.co.za](mailto:info@miele.co.za)

Internet: [www.miele.co.za](http://www.miele.co.za)

### Thailand

Miele Appliances Ltd.

BHIRAJ TOWER at EmQuartier

43rd Floor Unit 4301-4303

689 Sukhumvit Road

North Klongton Sub-District

Vadhana District

Bangkok 10110, Thailand

### United Arab Emirates

Miele Appliances Ltd.

Showroom 1, Eiffel 1 Building

Sheikh Zayed Road, Umm Al Sheif

P.O. Box 114782 - Dubai

Tel. +971 4 3044 999

Fax. +971 4 3418 852

800-MIELE (64353)

E-Mail: [info@miele.ae](mailto:info@miele.ae)

Website: [www.miele.ae](http://www.miele.ae)

DAS 2620, DAS 2920, DAS 2620 EXTA, DAS 2920 EXTA